



DIGITAL MIXING RESHAPED

ALLEN & HEATH

# Introducing the New Compact Digital Mixers from Allen & Heath

We have been creating high end mixing consoles for some of the most discerning ears in the business since 1969. We're not a software house, we don't make stomp boxes or cable testers – creating excellent mixers is, has been and always will be our great passion. Qu mixers have been designed by our in-house research and development team in Cornwall, Great Britain, and are directly descended from the GLD and iLive digital mixing systems that have earned the industry's respect night after night on tour and in live venues across the globe – so you can be confident that you're standing behind a premium mixer that looks, feels, and sounds like a pro.

Qu mixers harness the full potential of digital mixing technology, with total recall of settings (including the all-important fader position and preamp gain), convenient recording and playback solutions, iPad control, personal monitoring options and the choice of local or remote Cat5 I/O.



## QU-24

24 MIC INPUTS	3 STEREO INPUTS	20 MIX OUTPUTS	25 MOTOR FADERS	2 STEREO MATRIX OUTS
2 STEREO GROUPS	4 MUTE GROUPS	4 FX ENGINES	4 FX SENDS / RETURNS	4 DCA GROUPS
USB AUDIO STREAMING	DAW MIDI CONTROL	AES DIGITAL OUT	CHANNEL DUCKER	10 SOFT KEYS



## QU-32

33 MOTOR FADERS	32 MIC INPUTS	3 STEREO INPUTS	24 MIX OUTPUTS	2 STEREO MATRIX OUTS
4 MUTE GROUPS	4 FX ENGINES	4 FX SENDS / RETURNS	4 STEREO GROUPS	4 DCA GROUPS
USB AUDIO STREAMING	DAW MIDI CONTROL	AES DIGITAL OUT	CHANNEL DUCKER	10 SOFT KEYS

## QU-16

16 MONO INPUTS	3 STEREO INPUTS	12 MIX OUTPUTS	17 MOTOR FADERS	
4 MUTE GROUPS	4 FX ENGINES	4 STEREO FX RETURNS	4 SOFT KEYS	4 DCA GROUPS
USB AUDIO STREAMING	DAW MIDI CONTROL	AES DIGITAL OUT	19" BACK MOUNTABLE	CHANNEL DUCKER



## QU-Pac

16-32 MIC INPUTS	3 STEREO INPUTS	12-24 MIX OUTPUTS	2 STEREO MATRIX OUTS	19" BACK MOUNTABLE
15 SOFT KEYS	16 CUSTOM SELECT KEYS	4 STEREO GROUPS	4 MUTE GROUPS	4 FX ENGINES
4 DCA GROUPS	USB AUDIO STREAMING	DAW MIDI CONTROL	AES DIGITAL OUT	CHANNEL DUCKER

## AnalogiQ™ Preamps

Our AnalogiQ™ total recall preamps feature zero crossing detection and an advanced padless 1dB step gain stage, closely allied to the DSP for optimal gain accuracy and audio transparency. The analogue signal is captured by high class, low latency 24bit analogue to digital converters matched to high quality 24bit digital to analogue converters to deliver the required outputs. The AnalogiQ™ design has been refined to offer superb transparency, minimal distortion and an ultra-low noise floor, with a warm, musical sound that is missing from some digital consoles.

## The Mixing Experience

Having massive processing power and advanced functionality is great, but it counts for nothing if you can't access the controls you need in a heartbeat. Once you start using a Qu you'll sense the years of research into ergonomics and the hands-on mixing experience that our team has drawn upon to deliver a wonderfully natural layout and workflow. It's not about recreating an analogue interface, it's about creating an experience that's fluid, comfortable and intuitive for novices, digital natives and old school road warriors alike, making all the benefits of digital mixing technology readily accessible to all.

## Fader Automation

Moving faders started as an expensive option in the studio desks of the 80s, and later became the norm with the advent of digital technology. Nevertheless some entry-level digital mixers lack this precious commodity which is a fundamental part of the Total Recall approach. Fader automation is essential for rapid mixing, especially when you're dealing with multiple monitor mixes – just press a mix key and the faders immediately fly to the send levels for that mix.

Qu-16, Qu-24 and Qu-32 feature 16, 24 and 32 motorized ALPS faders respectively, arranged over 2 layers, allowing instant access to all channels and masters in a compact space, plus a dedicated master fader which dynamically follows the mix selection. A third, Custom layer is available for ad-hoc user strip layout, where any combination of Inputs, FX Sends, FX Returns, Mix masters and MIDI strips can be assigned.



## Total Recall

True digital mixing is about being able to save and recall scenes (snapshots) at the press of a button. Qu can store up to 100 full Scenes for recall at will. Channels and mixes can be made Safe from Scene recall. For example, if an instrument or mic gets swapped out after the soundcheck, the channel can be made safe to avoid settings being overridden by Scene recalls. Or if a broadcast feed or walk-in iPod is added last-minute before the show kicks off, that mix or channel can be made safe from any scene change. In addition, single parameter updates can be blocked using a Recall Filter. So if you tweak the graphic EQ to reflect the room response when the audience gets in, you can block this to prevent any overwriting at scene change.

Custom settings for each EQ, compressor or channel can be saved as Library presets. This lets you store your tried and tested setting for your favourite vocal mic or reverb pattern and apply it to other channels or shows. Libraries, Scenes and the complete Show configuration can be saved to a USB key, so you can carry the show with you, ready to use on another Qu mixer.

## Touch Control

The 800 x 480, sixteen million colour Touchscreen and its dedicated data encoder form the heart of the Qu interface, providing super-fast, easy access to all settings. The user-friendly interface has been designed with clarity in mind. Dedicated keys and screen tabs quickly guide you to meter and RTA views, FX racks, channel processing, USB audio control, scenes, setup menus and much more.



## iLive FX

Qu's dynamics and FX algorithms are derived from the FX used in our iLive pro touring series. Some of the world's most respected audio engineers have chosen to use iLive's FX on tour in preference to top-end plug-ins and external FX units. All Qu models boast 4 stereo iLive FX engines, featuring lovingly crafted emulations of legendary classic reverbs, gated reverbs, delays, modulators, flangers and more.

The FX library has the ability to grow with future firmware releases. FX are returned to the mix on dedicated return channels, so you're not tying up your mono and stereo input channels. Each Stereo FX Return has a dedicated 4 band PEQ.



## Qu-Drive

Forget soundcard drivers and software setup, Qu has an integrated multitrack USB recorder, providing 18 channels of 48kHz, 24bit recording and playback straight to / from your USB hard drive. Capturing multitrack recordings of your shows has never been so easy. Mixes and FX returns can be recorded alongside channels, and multitrack audio can be played back to the mixer for virtual sound-checks.

An independent set of controls is provided for quick stereo recording of the main LR or other mix outputs, and a 2-track USB return can be routed to ST3 for playback of stereo WAV files such as walk-in music.



## The SuperStrip

On Qu-16, Qu-24 and Qu-32 all your key processing tools are presented in a clean layout on the SuperStrip, with 1 function per physical control. The SuperStrip is complemented by an onscreen TouchChannel for intuitive access to full processing parameters without clutter or complex menu structures. Processing for Mono and Stereo inputs includes trim, polarity, HPF, gate, insert, 4 band PEQ, compressor and delay. All mixes including LR provide Insert, 4 band PEQ, 1/3 octave GEQ, compressor and delay.

On Qu-Pac, the new Channel screen replaces the physical fader strips. Different tabs provide access to Input Channels, FX, Groups, Mixes, DCA and Mute Groups. Tap on a channel to select and the Virtual Fader strip gives control of level, mute, pan and PAFL for the selected channel. Tap on the Current Mix box to select a different Mix.



## Channel Ducker

An advanced yet easy to use Ducker is now available on every channel. It can be inserted on the fly on any number of Inputs and Stereo Groups, providing auto signal attenuation and then gently restoring the level to aid the operator in endless applications: reduce the level of background music when a single microphone or mic mix is in use, for example during live announcements, or give a chairman microphone priority over others. Setup is a breeze, with the option to share Ducker settings across multiple channels when in Gang mode.

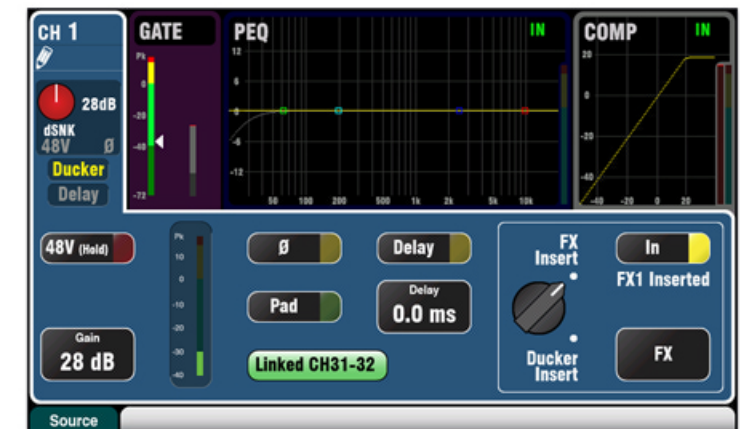

## USB Audio Streaming

Qu's built-in interface streams multitrack audio to your Mac or PC via a flexible patching system: all Input channels and the Main LR can be recorded at the same time, or you may choose to record something different such as FX returns or a pair of mixes.

The returns from the computer can be assigned to the Input channels. The interface is class-compliant on Mac OS X – and drivers are available for Windows systems. Either way, it will be recognized straightaway by any DAW supporting ASIO or Core Audio, including Logic, Cubase, Reaper, and Pro Tools.



# QU-16

RACKMOUNTABLE DIGITAL MIXER  
FOR LIVE, STUDIO AND INSTALLATION

16 MONO INPUTS	3 STEREO INPUTS	12 MIX OUTPUTS	17 MOTOR FADERS
4 MUTE GROUPS	4 FX ENGINES	4 STEREO FX RETURNS	4 SOFTKEYS
USB AUDIO STREAMING	DAW MIDI CONTROL	AES DIGITAL OUT	19" RACK MOUNTABLE
			CHANNEL DUCKER

With 24 sources to the mix including stereo inputs and returns, Qu-16 is the equivalent of a 30 channel analogue console with extensive outboard equipment (22 gates, 34 compressors, 12 graphic equalizers and 4 stereo effects)! Add the unique Qu-Drive recording facilities, dSNAKE connectivity and Total Recall scene system and you get a true powerhouse in just 19 inches.



- Balanced Stereo Inputs
- Ethernet network port for remote / wi-fi control
- dSNAKE™ Remote Audio port for digital snake and personal monitoring
- USB audio streaming, class-compliant on Mac



- All 12 Mix outputs on XLR
- 2TRK Out
- Patchable Alt Out
- AES digital stereo output
- Dedicated Talkback preamp

Quickly access preamp gain, HPF frequency, PEQ settings, gate & compressor threshold, and PAN.

GEQ Flip toggles the faders to Graphic EQ sliders.

Copy, Paste or Reset any section of processing or a whole channel or mix. The Fn (Function) key brings up a popup page relevant to the current screen.

Fader strips with Mute, Select, PAFL switches, signal meter, and 100mm motorised fader. Access all the processing for each strip with Sel. The Peak indicators are multi-point – they are triggered by any signal clip in the channel path.

16 faders in 3 layers give access to all channels and masters in a compact space. Assign any combination of Inputs, FX sends, FX returns and Mix masters to the Custom layer.

5" 800x480 colour touchscreen with dedicated navigation keys and rotary encoder.

Qu-Drive multitrack / stereo recording and playback, data transfer, archiving and firmware update.

ST3 Mini-jack stereo input for portable devices.

Access mix sends on faders with the dedicated Mix keys.

4 user-assignable SoftKeys for scene recall, mutes, tap tempo and more.



Motorised faders provide total recall of mix levels, giving full benefit from the scene recall system and ensuring the fader is always in the right position even when swapping between the layers.



Qu's high resolution, full colour Touchscreen and the intuitive Touch Channel interface provide easy access to channel processing, the FX racks and all setup and system management controls.



Qu features crystal clear AnaLOGIQ total recall pad-less preamps, optimised for transparency and low harmonic distortion.



Qu-Drive is an integrated USB recorder, allowing multitrack recording and playback to/from an external USB drive.



Qu features a library of FX emulations taken from the iLive pro touring series, including classic reverbs, gated reverbs, delays and modulators.



Allen & Heath's proprietary dSNAKE™ low latency audio connection enables Cat5 connection to a remote audio rack, or to the ME personal mixing system.



Qu is compatible with Allen & Heath's ME Personal Mixing System – so you can add ME-1 personal mixers to your setup to allow performers to control their own monitor mixes.



A free iPad app gives instant wireless control of the mixer, so you can tweak the PA, adjust the monitors on stage, and even mix the show from the audience.



Qu-You allows up to seven performers to control their monitor mixes using an iPhone, iPad or iPod Touch. Qu-You is compatible with all Qu series mixers.

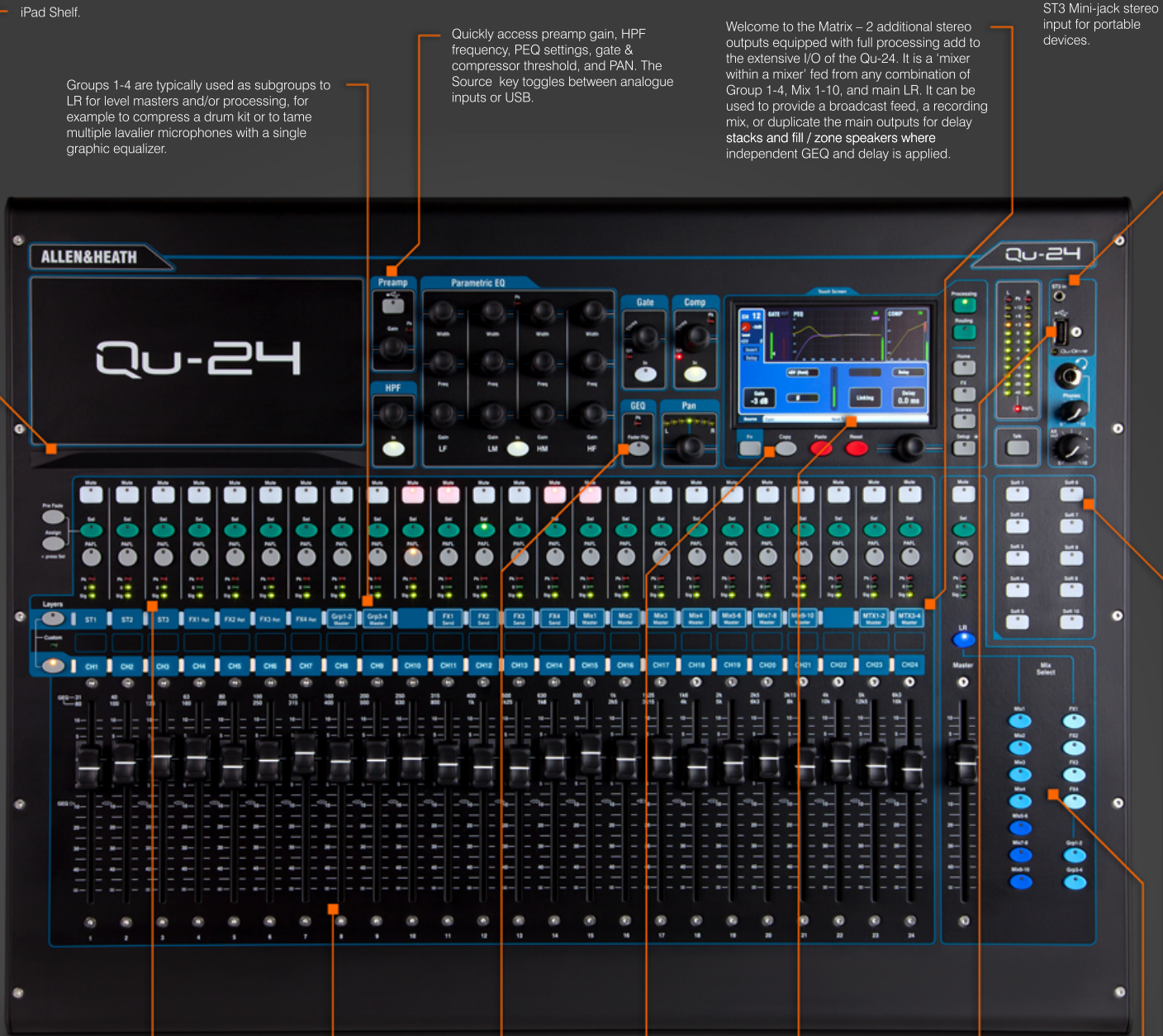

iPad Shelf.

Groups 1-4 are typically used as subgroups to LR for level masters and/or processing, for example to compress a drum kit or to tame multiple lavalier microphones with a single graphic equalizer.

Quickly access preamp gain, HPF frequency, PEQ settings, gate & compressor threshold, and PAN. The Source key toggles between analogue inputs or USB.

Welcome to the Matrix – 2 additional stereo outputs equipped with full processing add to the extensive I/O of the Qu-24. It is a 'mixer within a mixer' fed from any combination of Group 1-4, Mix 1-10, and main LR. It can be used to provide a broadcast feed, a recording mix, or duplicate the main outputs for delay stacks and fill / zone speakers where independent GEQ and delay is applied.

ST3 Mini-jack stereo input for portable devices.

24 MIC INPUTS	3 STEREO INPUTS	20 MIX OUTPUTS	25 MOTOR FADERS	2 STEREO MATRIX OUTPUTS
2 STEREO GROUPS	4 MUTE GROUPS	4 FX ENGINES	4 FX SENDS / RETURNS	4 DCA GROUPS
USB AUDIO STREAMING	DAW MIDI CONTROL	AES DIGITAL OUT	CHANNEL DUCKER	10 SOFT KEYS

# QU-24

COMPACT DIGITAL MIXER  
FOR LIVE, STUDIO AND INSTALLATION

With 32 sources to the mix including stereo inputs and returns, Qu-24 is the equivalent of a 38 channel analogue console with extensive outboard equipment (30 gates, 50 compressors, 20 graphic equalizers and 4 stereo effects)! On top of this Qu-24 adds extra SoftKeys, a complete Matrix system and two stereo Groups.



**TOTAL RECALL MOVING FADERS**  
Motorised faders provide total recall of mix levels, giving full benefit from the scene recall system and ensuring the fader is always in the right position even when swapping between the layers.



**800X480 TOUCHSCREEN TOUCH CONTROL**  
Qu's high resolution, full colour Touchscreen and the intuitive Touch Channel interface provide easy access to channel processing, the FX racks and all setup and system management controls.



**AnalOGiQ RECALLABLE PREAMP**  
Qu features crystal clear AnalOGiQ total recall pad-less preamps, optimised for transparency and low harmonic distortion.



**MULTITRACK RECORD/PLAY QU-Drive**  
Qu-Drive is an integrated USB recorder, allowing multitrack recording and playback to/from an external USB drive.



**iLive FX**  
Qu features a library of FX emulations taken from the iLive pro touring series, including classic reverbs, gated reverbs, delays and modulators.



**dSNAKE REMOTE AUDIO**  
Allen & Heath's proprietary dSNAKE™ low latency audio connection enables Cat5 connection to a remote audio rack, or to the ME personal mixing system.



**ME PERSONAL MIXING SYSTEM**  
Qu is compatible with Allen & Heath's ME Personal Mixing System – so you can add ME-1 personal mixers to your setup to allow performers to control their own monitor mixes.



**IPAD APP QU-PAD**  
A free iPad app gives instant wireless control of the mixer, so you can tweak the PA, adjust the monitors on stage, and even mix the show from the audience.



**PERSONAL MONITORING APP QU-YOU**  
Qu-You allows up to seven performers to control their monitor mixes using an iPhone, iPad or iPod Touch. Qu-You is compatible with all Qu series mixers.

Fader strips with Mute, Select, PAFL switches, signal meter, and 100mm motorised fader. Access all the processing for each strip with Sel. The Peak indicators are multi-point – they are triggered by any signal clip in the channel path.

24 faders in 3 layers give access to all channels and masters in a compact space. Assign any combination of Inputs, FX sends, FX returns, Groups, Mix and Matrix masters to the Custom layer.

GEQ Flip toggles the faders to Graphic EQ sliders.

Copy, Paste or Reset any section of processing or a whole channel or mix. The Fn (Function) key brings up a popup page relevant to the current screen.

5" 800x480 colour touchscreen with dedicated navigation keys and rotary encoder.

Qu-Drive multitrack / stereo recording and playback, data transfer, archiving and firmware update.

Access mix sends on faders with the dedicated Mix keys.

Qu-24 packs 10 SoftKeys for more user-assignable functions such as Mute Groups, Tap Tempo, Scene navigation or PAFL Clear.



- Balanced Stereo Inputs
- Ethernet network port for remote / wi-fi control
- dSNAKE™ Remote Audio port for digital snake and personal monitoring
- USB audio streaming, class-compliant on Mac
- All 20 Mix outputs on XLR
- 2TRK Out
- Patchable Alt Out
- AES digital stereo output
- Dedicated Talkback preamp



# QU-32

COMPACT DIGITAL MIXER  
FOR LIVE, STUDIO AND INSTALLATION

33 MOTOR FADERS	32 MIC INPUTS	3 STEREO INPUTS	24 MIX OUTPUTS	2 STEREO MATRIX OUTS
4 MUTE GROUPS	4 FX ENGINES	4 FX SENDS / RETURNS	4 STEREO GROUPS	4 DCA GROUPS
USB AUDIO STREAMING	DAW MIDI CONTROL	AES DIGITAL OUT	CHANNEL DUCKER	10 SOFT KEYS

With 4 DCAs and 40 sources to the mix including stereo inputs and returns, Qu-32 is the equivalent of a 46 channel, 8 groups, 4 VCA analogue console with extensive outboard equipment (38 gates, 62 compressors, 24 graphic equalizers and 4 stereo effects)!

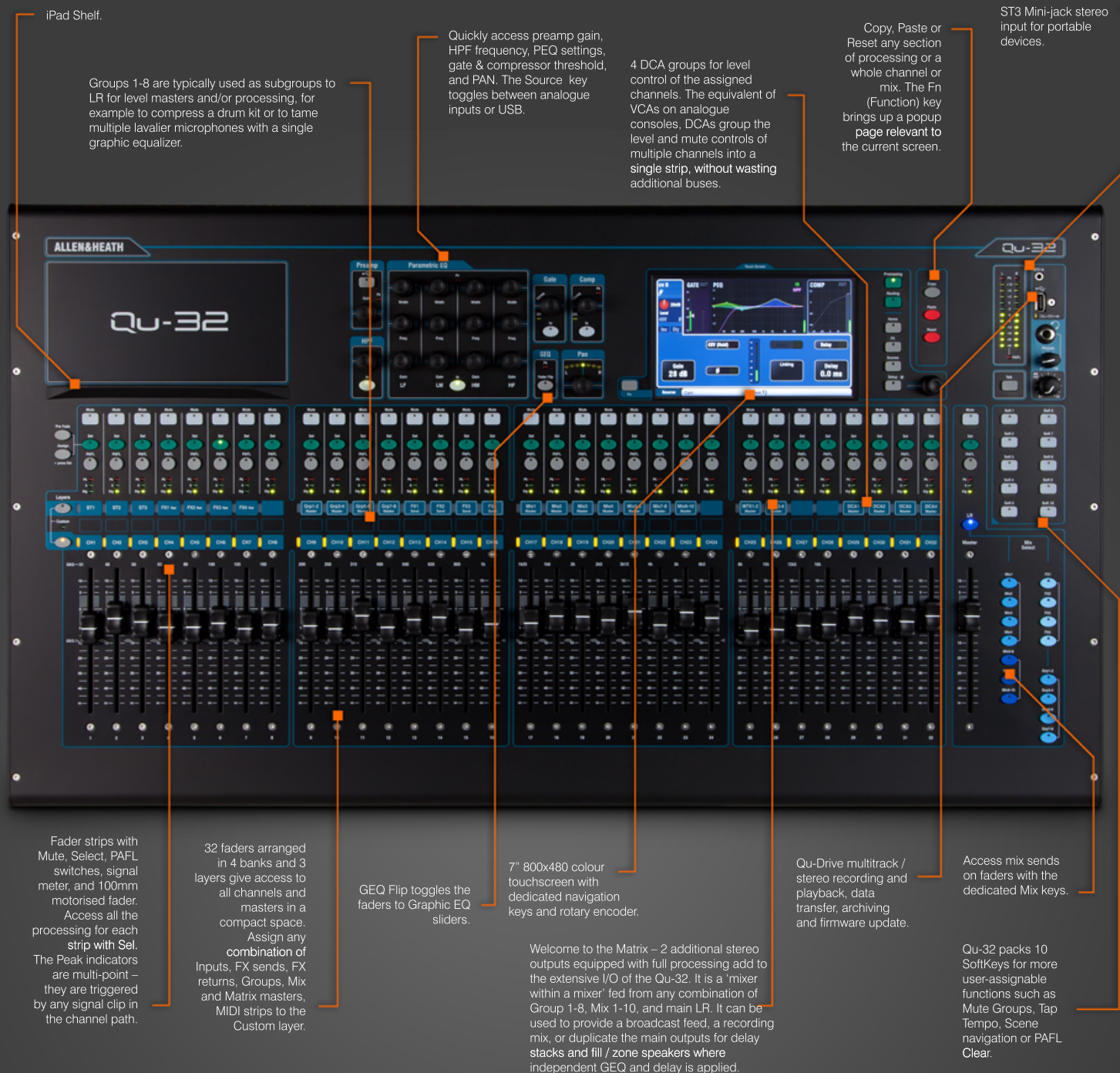

**TOTAL RECALL MOVING FADERS**  
Motorised faders provide total recall of mix levels, giving full benefit from the scene recall system and ensuring the fader is always in the right position even when swapping between the layers.



**800x480 TOUCHSCREEN TOUCH CONTROL**  
Qu's high resolution, full colour Touchscreen and the intuitive Touch Channel interface provide easy access to channel processing, the FX racks and all setup and system management controls.



**AnaLOGIQ RECALLABLE PREAMP**  
Qu features crystal clear AnaLOGIQ total recall pad-less preamps, optimised for transparency and low harmonic distortion.



**MULTITRACK RECORD/PLAY Qu-Drive**  
Qu-Drive is an integrated USB recorder, allowing multitrack recording and playback to/from an external USB drive.



**iLive FX**  
Qu features a library of FX emulations taken from the iLive pro touring series, including classic reverbs, gated reverbs, delays and modulators.



**dSNAKE REMOTE AUDIO**  
Allen & Heath's proprietary dSNAKE™ low latency Cat5 connection to a remote audio rack, or to the ME personal mixing system.



**ME PERSONAL MIXING SYSTEM**  
Qu is compatible with Allen & Heath's ME Personal Mixing System – so you can add ME-1 personal mixers to your setup to allow performers to control their own monitor mixes.



**IPAD APP Qu-Pad**  
A free iPad app gives instant wireless control of the mixer, so you can tweak the PA, adjust the monitors on stage, and even mix the show from the audience.



**PERSONAL MONITORING APP Qu-You**  
Qu-You allows up to seven performers to control their monitor mixes using an iPhone, iPad or iPod Touch. Qu-You is compatible with all Qu series mixers.

- 1 Balanced Stereo Inputs
- 2 Ethernet network port for remote / wi-fi control
- 3 dSNAKE™ Remote Audio port for digital snake and personal monitoring
- 4 USB audio streaming, class-compliant on Mac



- 5 All 24 Mix outputs on XLR
- 6 2TRK Out
- 7 Patchable Alt Out
- 8 AES digital stereo output
- 9 Dedicated Talkback preamp





## Qu-Control

Qu-Control brings up a fully customizable screen which gives access to channels and settings tailored to the user and application. Several 'widgets' can be assigned to the page, these include channel levels, mutes and assignment on/off switches and are arranged to suit the user requirement, for example as a source selection and level control of background music to one or multiple zones.

15 SoftKeys for user-assigned functions such as Mutes, Tap Tempo, Instant Scene Recall/Navigation or PAFL Clear.

5" 800x480 colour touchscreen with dedicated navigation keys and rotary encoder.

ST3 Mini-jack stereo input for portable devices.

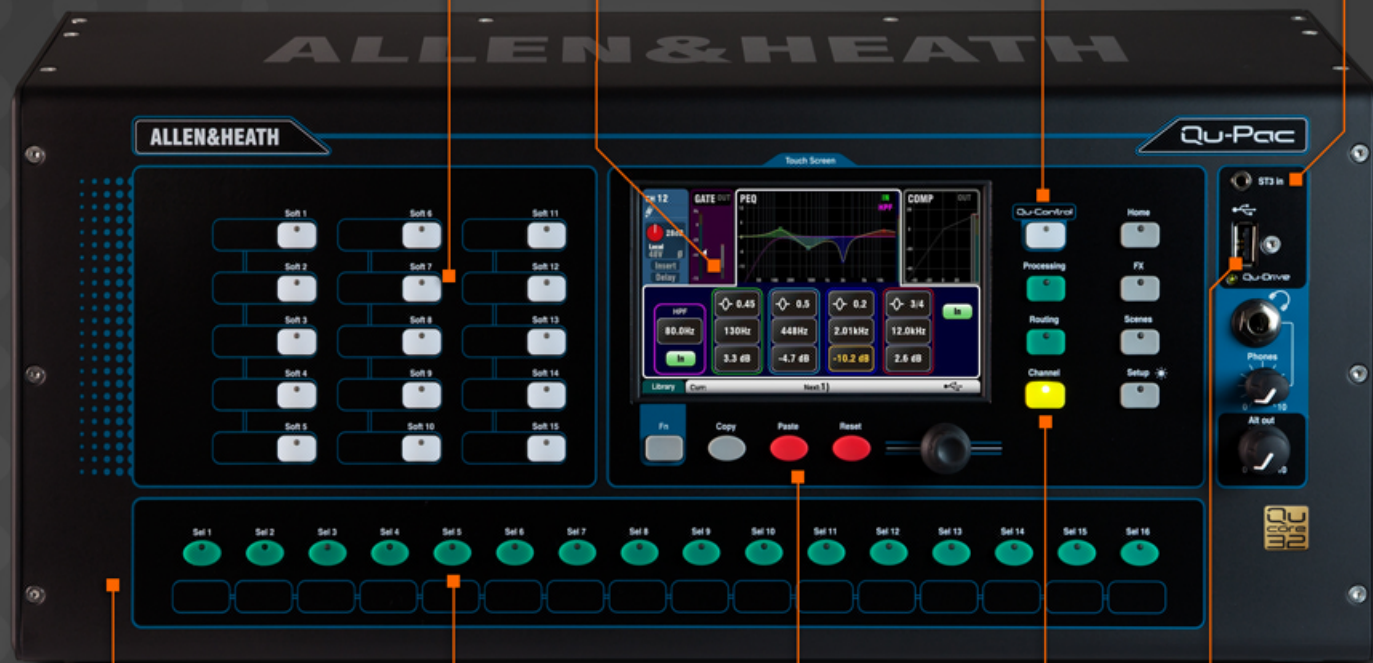

Ultra-compact chassis for desktop or rack mounting (4 rack spaces).

16 custom select keys for quick access to any combination of inputs and masters.

Copy, Paste or Reset any section of processing or a whole channel or mix. The Fn (Function) key brings up a popup page relevant to the current screen.

Channel Screen gives access to any input / master / DCA masters from the front panel.

Qu-Drive multitrack / stereo recording and playback, data transfer, archiving and firmware update.

16-32 MIC INPUTS	3 STEREO INPUTS	12-24 MIX OUTPUTS	2 STEREO MATRIX OUTS	19" RACK MOUNTABLE
15 SOFT KEYS	16 CUSTOM SELECT KEYS	4 STEREO GROUPS	4 MUTE GROUPS	4 FX ENGINES
4 DCA GROUPS	USB AUDIO STREAMING	DAW MIDI CONTROL	AES DIGITAL OUT	CHANNEL DUCKER

# QU-PAC

ULTRA COMPACT DIGITAL MIXER

FOR LIVE, STUDIO AND INSTALLATION

Qu-Pac takes the power and legendary quality of the Qu family and shrinks it into an uber-compact desk or rack mount format. Qu-Pac frees you to mix from your iPad, but the full functions of the mixer can also be accessed from the front panel and touchscreen.

User permissions and the customizable Qu-Control screen make Qu-Pac convenient and safe for day-to-day use by non-technical staff.

With custom settings and Cat5 expansion up to 38 inputs, Qu-Pac provides a scalable, failsafe solution for hardworking bands, schools, hotels, corporate events, live music bars, conferences, personal mixing and many more scenarios requiring a pro mixing solution in a tiny footprint.



Qu-Pac has the built-in I/O of a Qu-16 mixer but with the 'brain' of a Qu-32, allowing it to handle up to 38 inputs when connected to our family of AudioRacks over up to 120m of Cat5 cable.



1 Balanced Stereo Inputs

2 Ethernet network port for remote / wi-fi control

3 dSNAKE™ Remote Audio port for digital snake expansion (up to 32 mics), personal monitoring and more outputs.

4 USB audio streaming, class-compliant on Mac



5 12 Mix Outputs on XLR, up to 24 via dSNAKE

6 2TRK Out

7 Patchable Alt Out

8 AES digital stereo output

9 Dedicated Talkback preamp



AB168  
Optional Audio Rack

Qu-Pac  
Rack Mounted (easy-fit rack ears included)



# Qu-Pad

Add the Qu-Pad iPad app to your Qu setup and you're free to adjust the monitors on stage, roam around the venue whilst tweaking the PA, and then mix the show from the heart of the audience. Qu-Pad connects to the mixer over Wi-Fi\* and gives instant access to all live mixing parameters and settings.

\*Requires the connection of a Wi-Fi router or access point to the Qu Network port.

# Qu-You

Qu-You allows up to seven performers to control their monitor mixes using an iPhone, iPad or iPod Touch, and frees up the engineer to focus on the audience.

The main Four Wheel Drive view presents all the key controls in a super easy format, with chunky thumbwheels to control 4 groups of sources, plus a master mute and output level control. Unlike some apps on the market, Qu-You shows all controls in either orientations (anyone who has ever tried to rotate an iPhone and play a guitar at the same time will know why this matters!).

# ME Personal Mixing System

Qu mixers are fully compatible with our ME Personal Mixing System. Any number of ME-1 personal mixers can be chained from the dSNAKE™ port (or from an AR2412 / AB168 AudioRack if you've got one connected to the dSNAKE™ port). Each performer can be given tailored control over their own mix, leaving the engineer free to focus on the audience experience.

Find out more at [allen-heath.com/ME](http://allen-heath.com/ME)

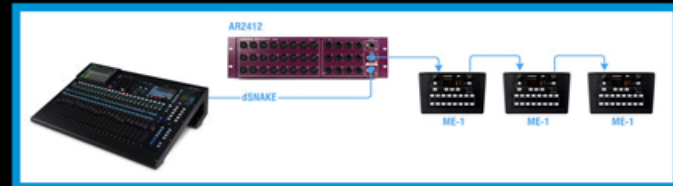

# Remote Audio

Qu mixers are self-contained, so if you've already got the analogue cables you're good to go. If you're thinking of trading in the copper multicore for a Cat5 digital snake, Qu's dSNAKE™ port has you future-proofed, allowing connection to a combination of AR2412, AR84 or portable AB168 AudioRacks.

dSNAKE™ is our proprietary networking solution, boasting a transport latency of only 105us over cable runs of up to 120m / 390'. So if you're mixing FoH you can place your I/O on the stage and run a single Cat5 cable back to the Qu mixer in the mix position.



## AR2412

24 inputs, 12 outputs AudioRack with dSNAKE™ connection, expansion port and dedicated EtherCon connection to the ME personal mixing system. 3u rack mount.

## AR84

8 inputs, 4 outputs AudioRack with dSNAKE™ connection. 1u rack mount.



## AB168

Portable rugged 16 inputs, 8 outputs stagebox with dSNAKE™ connection and expansion port.

## Qu in the Studio

Qu mixers can sit at the heart of your studio and double as a tracking desk, audio interface and DAW controller.

The built-in USB interface can handle up to 32x32\* channels full-duplex of high quality 24bit 48kHz audio. MIDI control is tunnelled over the USB connection and the Custom layer can be populated with MIDI strips for direct assignment or 'learning' of faders and Mute, Sel and PAFL keys in the DAW.

You can also download the free DAW Control app for Mac OS X, which translates the standard MIDI messages to popular HUI or Mackie Control protocols, for easier setup and deeper integration with the mixer.

Add one or more ME-1s for personal foldback mixes to the recording room.

\* 24x22 on Qu-16, 32x30 on Qu-24

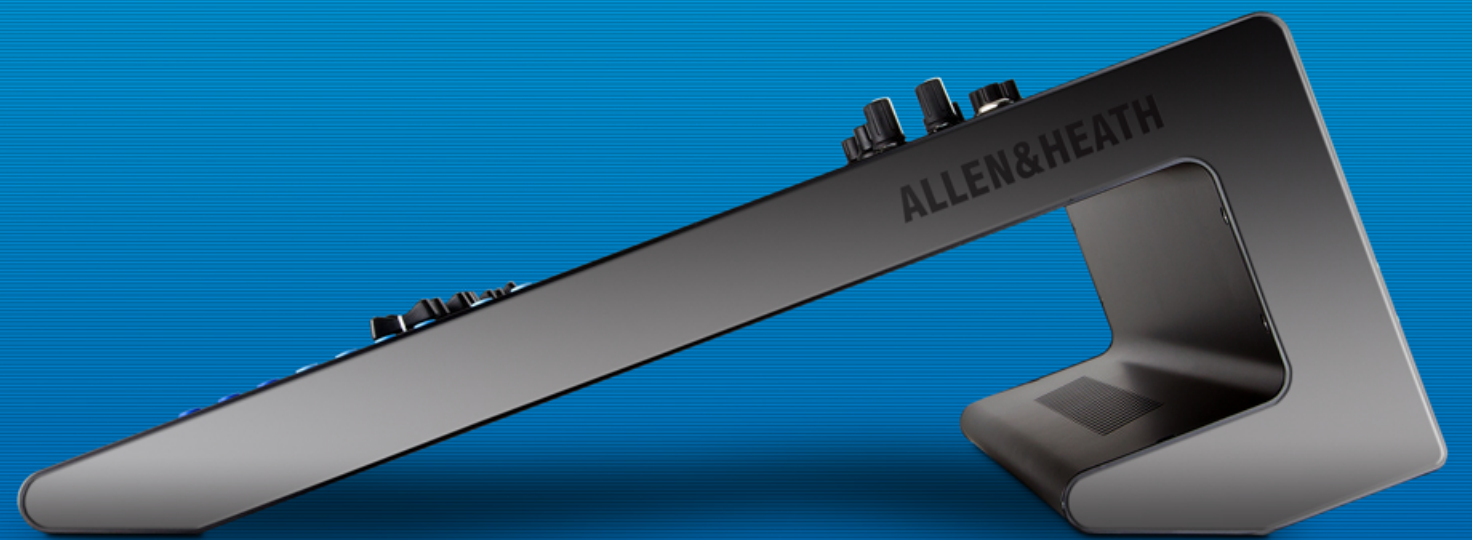

## ARMed to the Hilt

Qu mixers are equipped with 5 cores of high efficiency ARM core processing, with dedicated ARM cores running the touchscreen display and surface, USB streaming, Qu-Drive multi-channel USB recording / playback, Ethernet and fader automation. Between them the ARM cores provide state-of-the-art processing, working in parallel to deliver extensive control, instant-on operation, and lightning-fast response.

The mixer's DSP farm exploits next generation dual core DSPs. With plenty of DSP power under the hood the channel processing is only using a fraction of capacity, so Qu is future-proofed, with ample room for updates and extra functionality.

The DSP architecture employs varied bit depths, tailored to specific algorithms, with 48 bits on critical EQ functions and a 56 bit accumulator on the mix bus where it really counts, allowing every nuance of the audio to be captured in the final mix.

## Digital Mixing Reshaped

Made from 18 gauge, cold-rolled Zintec steel, Qu's distinctive frame is designed for strength and rigidity. We've done unspeakable things to that chassis in the lab and it's taken everything we've thrown at it – even being stomped on by our resident ex-tank commander.

Silence is a precious commodity in the live or studio environment, which is why nobody wants those moments of stillness ruined by the whirring of fans coming from the mix position. Qu's sleek profile generates optimal airflow through the mixer, eliminating the need for any fans.

The shape has some unexpected benefits too. When we started taking Qu out to gigs we soon found the space beneath it incredibly useful for keeping our USB drive, talkback mic, cue sheet and other clutter tucked out of the way. We've even had engineers hanging the mixer from a handy scaffold bar and mixing vertically.

# Applications

## Qu-16 + AB168

Rugged digital box for all 16 mono inputs and up to 8 returns, plus Qu-Drive direct recording on USB media.

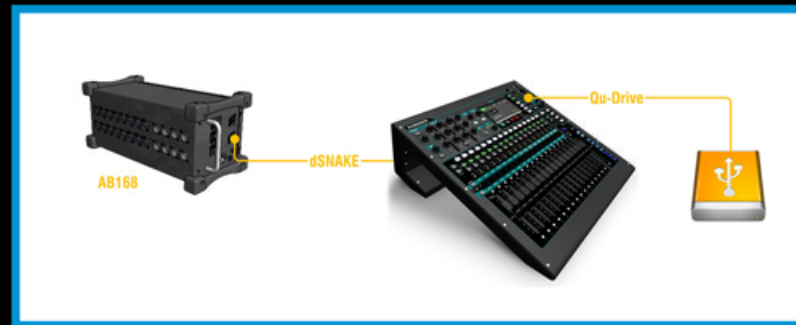

## Qu-Pac + AB168 + Qu-Pad

Qu-Pac as a rackmounted install mixer operated from the touchscreen, with occasional live shows benefiting from 32 remote XLR inputs on stage and wireless tablet mixing.



## In the Studio

Qu-16 as a tracking desk, audio interface, monitor router and DAW Controller.

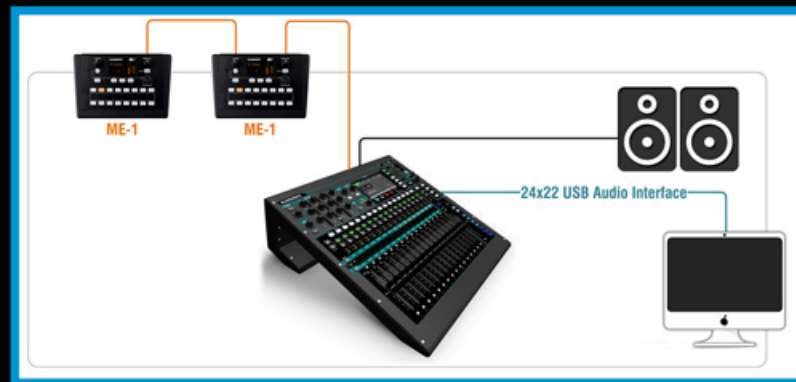

# Accessories

- AH9650** – 100m drum of EtherFlex Cat5 with locking Neutrik EtherCon connectors.
- AH9981** – 50m drum of EtherFlex Cat5 with locking Neutrik EtherCon connectors.
- AH9651** – 20m EtherFlex Cat5 with locking Neutrik EtherCon connectors.
- LEDLamp** – Variable brightness 18" gooseneck lamp.
- QU-16-RK19** – Rack mounting kit for Qu-16.
- AP9262** – Dust cover for Qu-16.
- AP9458** – Dust cover for Qu-24.
- AP9639** – Dust cover for Qu-32.
- AP9932** – AB168 Bag.
- AP9931** – Qu-16 Bag.
- AP9933** – Qu-Pac Bag



# Block Diagrams

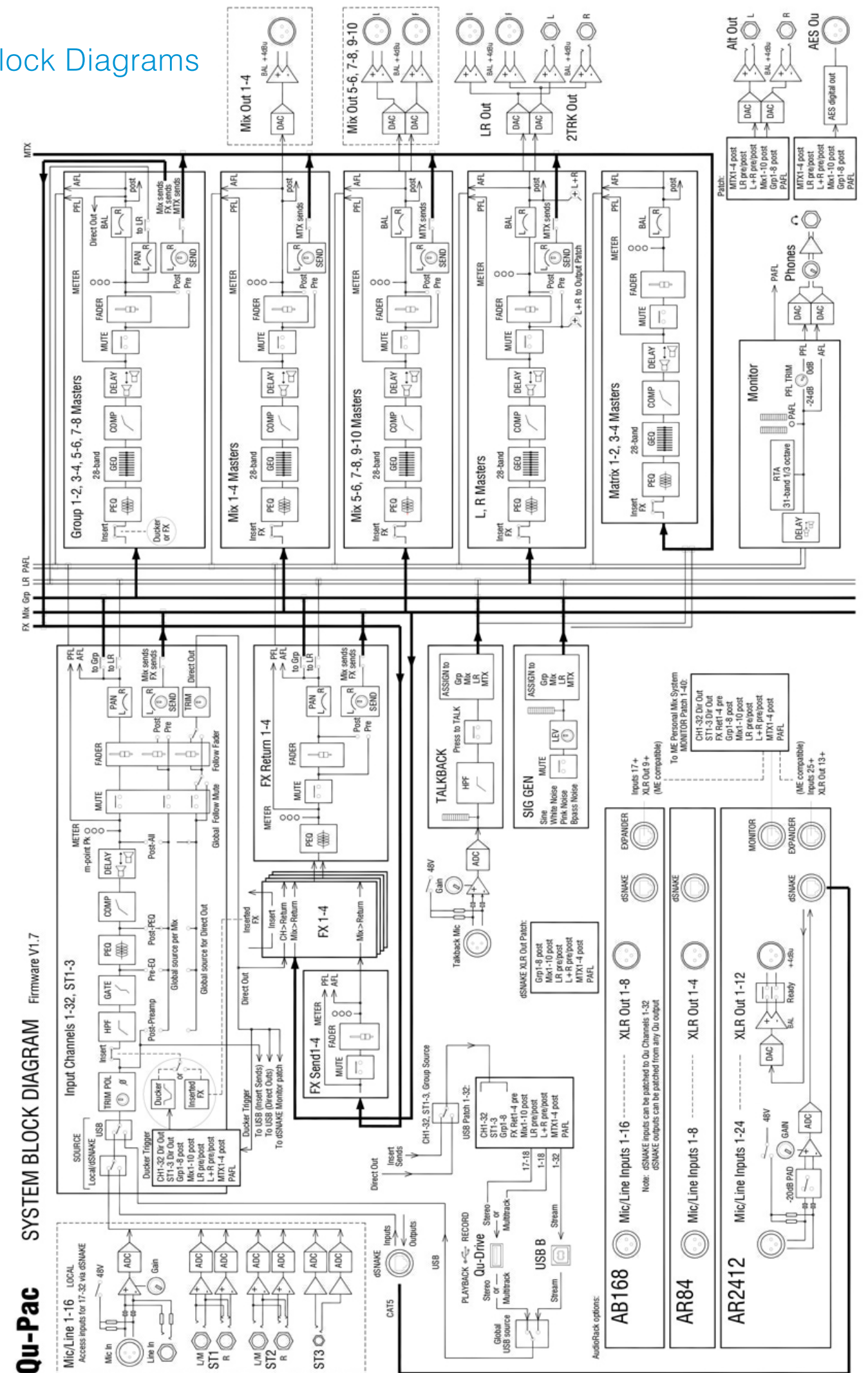

**Qu-16** SYSTEM BLOCK DIAGRAM Firmware V1.7

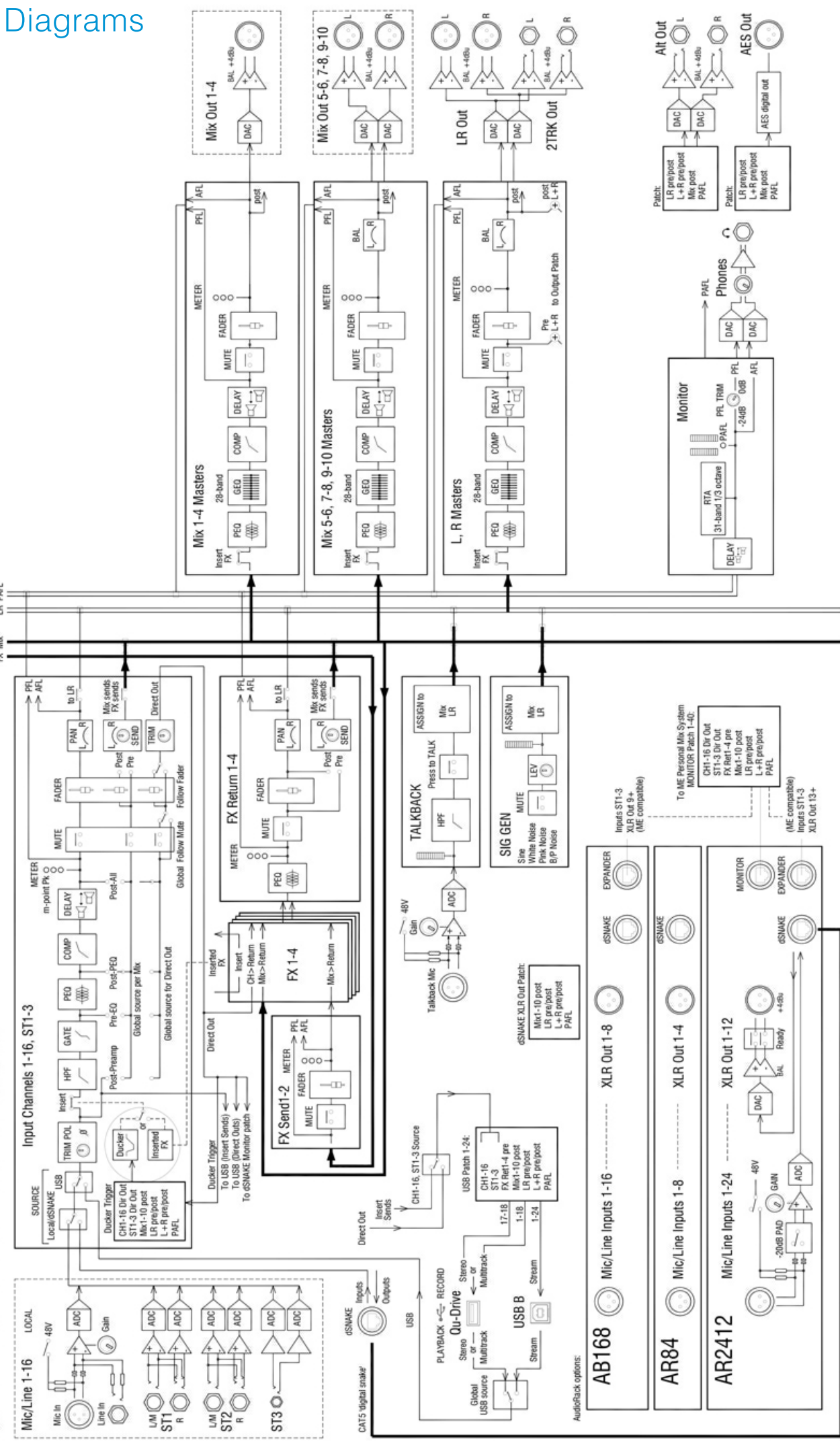

**Qu-24(32)** SYSTEM BLOCK DIAGRAM Firmware V1.7

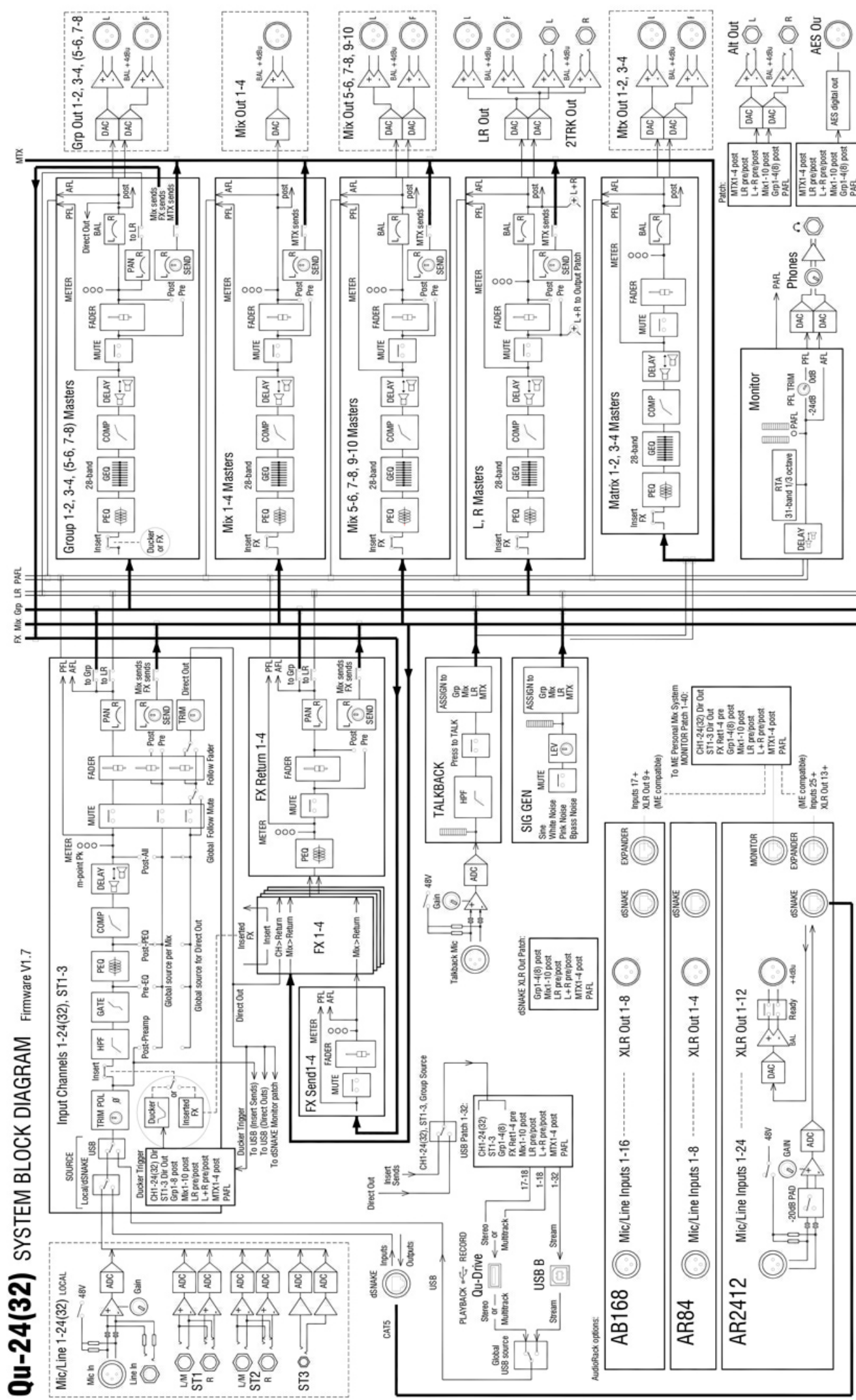

# Technical Specifications

## Qu-16, Qu-24, Qu-32, Qu-Pac specification

<b>Inputs</b>	<b>Mic/Line Inputs</b>	Balanced, XLR and 1/4" TRS jack, fully recallable	
	Input Sensitivity (XLR / TRS)	-60 to +5dBu / -50 to +15dBu	
	Analogue Gain	-5 to +60dB, 1dB steps	
	Maximum Input Level (XLR / TRS)	+19dBu / +29dBu	
	Input Impedance (XLR / TRS)	> 5kΩ / > 10 kΩ	
	THD+N, Unity gain 0dB	0.0005% -89 dBu (20-20kHz, Direct Out @0dBu 1kHz)	
	THD+N, Mid gain +30dB	0.001% -83dBu (20-20kHz, Direct Out @0dBu 1kHz)	
<b>Stereo Line Inputs</b>	ST1, ST2 connector	Balanced, 1/4" TRS jack, half normalised	
	ST3 connector	Unbalanced, stereo 3.5mm Mini Jack	
	Input Sensitivity (ST1, ST2 / ST3)	Nominal +4dBu / 0dBu	
	Trim	+/-24dB	
	Maximum Input Level (ST1, ST2 / ST3)	+22dBu / +18dBu	
	Input Impedance	>7kΩ	
	<b>Outputs</b>	<b>Mix1-10 and LR Out</b>	Balanced, XLR
<b>Group and Matrix Out (Qu-24,32 only)</b>			
Output Impedance		<75Ω	
Nominal Output		+4dBu = 0dB meter reading	
Maximum Output Level		+22dBu	
Residual Output Noise		-90 dBu (muted, 20-20kHz)	
<b>Stereo Alt Out &amp; 2Trk Out</b>		Balanced, 1/4" TRS jack	
Source (Alt Output / 2Trk Output)		Patchable / LR post-fade	
Output Impedance		<75Ω	
Nominal Output		+4dBu = 0dB meter reading	
Maximum Output Level	+22dBu		
Residual Output Noise	-90 dBu (muted, 20-20kHz)		
<b>AES Digital Output</b>	2 channel, 48kHz sampling rate, XLR	2.5Vpp balanced terminated 110Ω	
<b>dSNAKE</b>	<b>Inputs</b>	Remote source for CH1-32, ST1, ST2, ST3	
	<b>Outputs</b>	Patchable from Mix1-10, LR, Grp1-8, MTX1-4 Compatible with AudioRacks AR2412, AR84, AB188 Compatible with ME personal mixing system	
<b>System</b>	Dynamic Range	112 dB	
	Frequency Response	+0/-0.5dB 20Hz to 20kHz	
	Headroom	+18dB	
	Internal operating Level	0dBu	
	dBFS Alignment	+18dBu = 0dBFS (+22dBu at XLR output)	
	Meter Calibration	0dB meter = -18dBFS (+4dBu at XLR out)	
	Meter Peak indication	-3dBFS (+19dBu at XLR out), multi-point sensing	
	Meter Signal indication	-48dBFS (-26dBu at XLR out)	
	Meter Type	Fast (peak) response	
	Sampling Rate	48kHz +/-100PPM	
	ADC, DAC	24-bit Delta-Sigma	
	Latency	1.2 ms (local XLR in to XLR out) 0.7 ms (local XLR in to AES out)	
	Operating Temperature Range	0 deg C to 35 deg C (32 deg F to 95 deg F)	
	Mains Power	100-240V AC, 50/60Hz	
	Power Consumption	16= 82W, 24= 120W, 32= 150W, Pac= 55W	
	<b>USB Audio</b>	<b>Qu-Drive</b>	USB A
		USB storage device	Refer to Qu Knowledgebase on website
Stereo Record		2 channel, WAV, 48kHz, 24-bit, patchable	
Stereo Playback		2 channel, WAV, 44.1 or 48kHz, 16 or 24-bit, to ST3	
Multitrack Record		18 channel, WAV, 48kHz, 24-bit, patchable	
Multitrack Playback		18 channel, WAV, 48kHz, 24-bit	
<b>USB Audio Streaming</b>		USB B, Core Audio compliant	
Send (upstream) Qu-16/24/32/Pac	24/32/32/32 channel, WAV, 48kHz, 24-bit		
Return (downstream) Qu-16/24/32/Pac	22/30/32/32 channel, WAV, 48kHz, 24-bit		
<b>Dimensions &amp; Weights</b>	<b>Qu-16 Mixer</b>	Width x Depth x Height	
	Desk mounted	440 x 500 x 186 mm (17.4" x 19.7" x 7.4")	
	Rack mounted	483 x 472 x 190 mm (19" x 18.6" x 7.5")	
	Packed in shipping box	610 x 680 x 350 mm (24" x 27" x 13.8")	
	Unpacked weight	10 kg (22 lbs)	
	Packed weight	13.5 kg (30 lbs)	
<b>Qu-24 Mixer</b>	Width x Depth x Height		
Desk mounted	632 x 500 x 186 mm (24.9" x 19.7" x 7.4")		
Packed in shipping box	670 x 790 x 350 mm (26.4" x 31.1" x 13.8")		
Unpacked weight	14 kg (31 lbs)		
Packed weight	18 kg (40 lbs)		

<b>Control</b>	Faders	100mm motorised (no faders on Qu-Pac)	
	Touch Screen Qu-16, 24, Pac	5" TFT, 800x480 resolution	
	Touch Screen Qu-32	7" TFT, 800x480 resolution	
	SoftKeys	4 (Qu-16), 10 (Qu-24, 32), 15 (Qu-Pac)	
	Mute Groups / DCA Groups	4 / 4	
	Network	TCP/IP Ethernet for MIDI and iPad app	
	<b>Input Processing</b>	<b>Source</b>	Local, dSNAKE, or USB
		CH1-32, ST1, ST2	Local, dSNAKE, or USB Stereo
		ST3	Local, dSNAKE, or USB Stereo
		USB Global Source	Qu-Drive or USB B Streaming
<b>Stereo Linking</b>		Odd/even input pairs	
Parameters linked	EQ, dynamics, insert, delay, assign, sends, Ducker		
Link options	Preamp, polarity, sidechains, fader/mute, pan		
<b>Polarity</b>	<b>High Pass Filter</b>	Normal/Reverse	
	<b>Insert</b>	12dB/octave 20Hz - 2kHz	
	<b>Delay</b>	FX or Ducker	
	<b>Gate</b>	Up to 85ms	
	<b>Threshold / Depth</b>	Self key Sidechain	
<b>Attack / Hold / Release</b>	-72dBu to +18dBu / 0 to 60dB		
<b>PEQ</b>	4-Band fully parametric, 20-20kHz, +/-15dB		
	Band 1, Band 4	Selectable LF Shelving (Baxandall), Bell	
	Band 2, Band 3	Bell	
	Bell Width	Non-constant Q, variable, 1.5 to 1/9th octave	
	<b>Compressor</b>	Self key Sidechain	
Threshold / Ratio	-46dBu to 18dBu / 1:1 to infinity		
Attack / Release	300us - 300ms / 100ms - 2s		
Knee	Soft/Hard		
Types	Peak Manual, RMS Manual, SlowOpto, PunchBag		
<b>Channel Direct Out</b>	Follow Fader, follow Mute (global options)		
	Source select (global)	Post-Preamp, Pre-EQ, Post-EQ, Post-Delay	
	<b>Mix Processing</b>	<b>Insert</b>	Groups = FX or Ducker. Mix/LR/Matrix = FX
		<b>Delay</b>	Up to 170ms
		<b>GEQ</b>	Constant 1/3 oct, 28 bands 31Hz-16kHz, +/-12dB Gain
<b>PEQ</b>		4-Band fully parametric, 20-20kHz, +/-15dB	
Band 1, Band 4		Selectable LF Shelving (Baxandall), Bell	
Band 2, Band 3	Bell		
Bell Width	Non-constant Q, variable, 1.5 to 1/9th octave		
<b>Compressor</b>	Self key Sidechain		
	Threshold / Ratio	-46dBu to 18dBu / 1:1 to infinity	
	Attack / Release	300us - 300ms / 100ms - 2s	
	Knee	Soft/Hard	
	Types	Peak Manual, RMS Manual, SlowOpto, PunchBag	
<b>Ducker</b>	Available on	CH1-32, ST1-3, Group	
	Trigger Source	Selectable from any input or output	
	Mode	Single or ganged channel ducking	
	Threshold / Depth	-72dBu to +18dBu / 0 to 60dB	
	Attack / Hold / Release	Fast, Medium, Slow	
<b>FX</b>	Internal FX	4x RackFX engine, Send>Return or Inserted	
	Types	Reverbs, Delays, Gated Reverb, ADT Chorus, Symphonic Chorus, Phaser, Flanger	
	4 dedicated Stereo FX returns	Fader, Pan, Mute, Routing to Mix/LR, 4-Band PEQ	
<b>Audio Tools</b>	<b>PAFL</b>	PFL or stereo in-place AFL, 0 to -24dB Trim, 85ms Delay	
	<b>Talkback</b>	Assignable to any mix, 12dB/oct HPF	
	<b>Signal Generator</b>	Assignable to any mix, Sine / White/Pink/Bandpass Noise	
	<b>RTA</b>	31-Bands 1/3 octave 20-20kHz, follows PAFL source	
<b>Dimensions &amp; Weights</b>	<b>Qu-32 Mixer</b>	Width x Depth x Height	
	Desk mounted	850 x 500 x 186 mm (33.5" x 19.7" x 7.4")	
	Packed in shipping box	1000 x 680 x 350 mm (39.4" x 26.8" x 13.8")	
	Unpacked weight	20 kg (44 lbs)	
	Packed weight	24 kg (53 lbs)	
	<b>Qu-Pac Mixer</b>	Width x Depth x Height	
Desk mounted	440 x 174 x 181 mm (17.3" x 6.9" x 7.1")		
Rack mounted	483 x 174 x 177 mm (19" x 18.6" x 7") 4U		
Packed in shipping box	620 x 310 x 310 mm (24.4" x 12.2" x 12.2")		
Unpacked weight	6.8 kg (14.5 lbs)		
Packed weight	8.5 kg (18.7 lbs)		